



# **VBV-770DM-S vehicle CCTV monitor**

**Quick installation guide**

**Guide d'installation rapide**

**Quick installation guide**

**Guida di installazione rapida**

**Guía rápida de instalación**

**Snelle installatie handleiding**



Stock code #3985



# 1 Contents

Contenu/Inhalt/Contenuti/Contenidos/inhoud

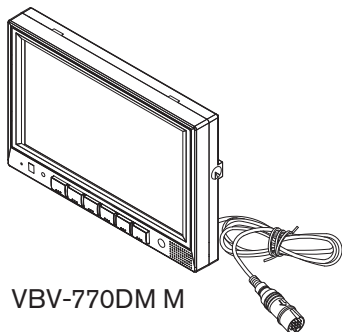

VBV-770DM M

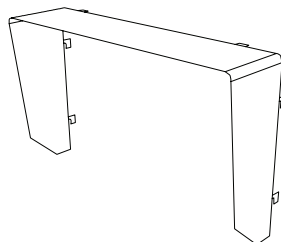

VBV-770DM SS

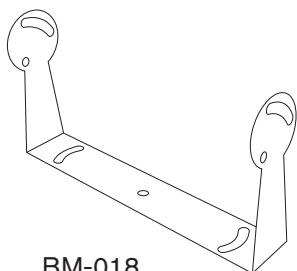

BM-018

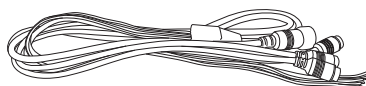

VBV-7X0DM SCA

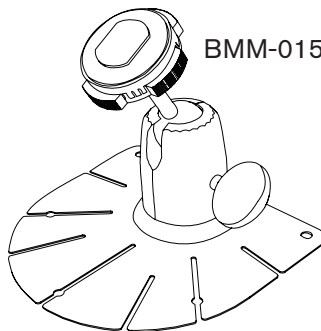

BMM-015

## 2 Monitor installation

Surveiller l'installation/Monitor-Installation/L'installazione del monitor/  
Vigilar la instalación/Monitor installatie

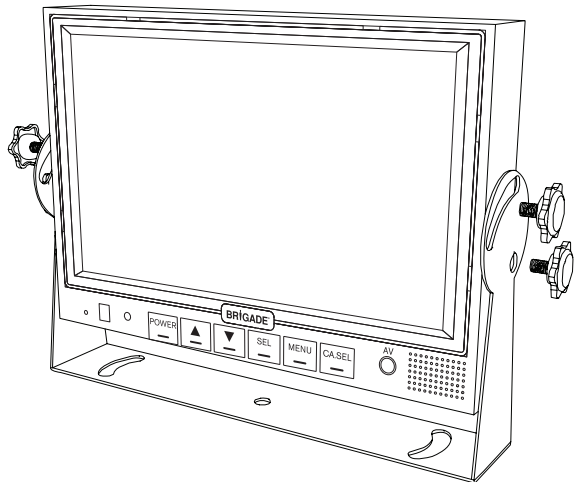
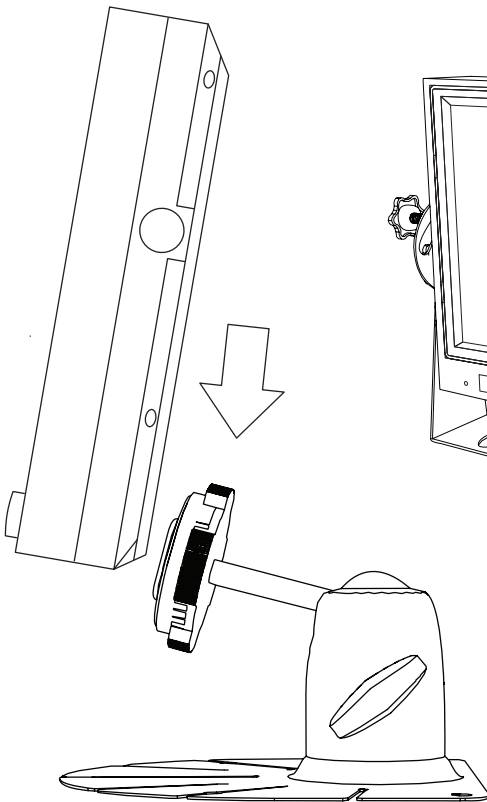
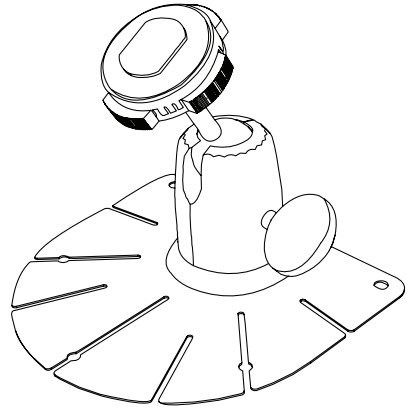
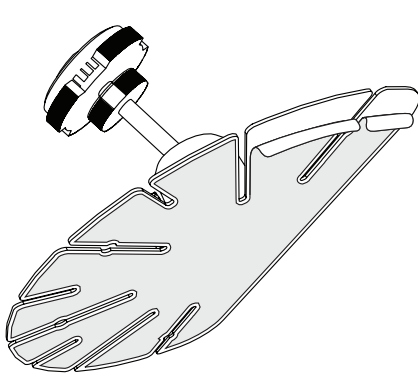

# 3 Connections

Connexions/Verbindungen/Connessioni/Conexiones/Aansluitingen

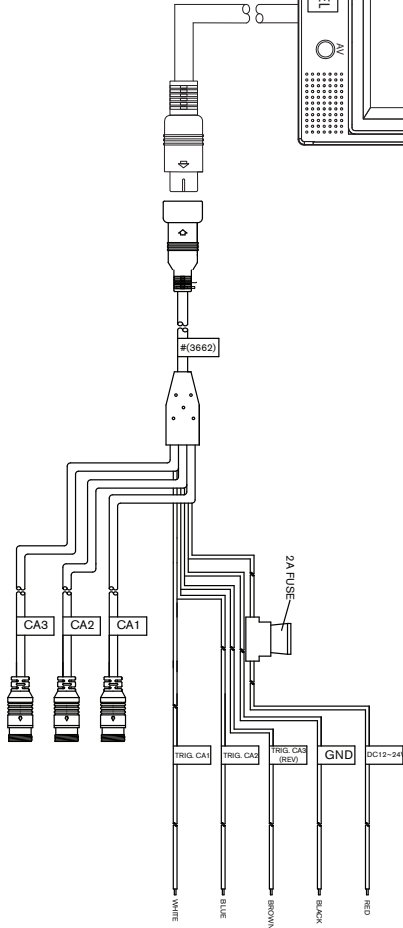
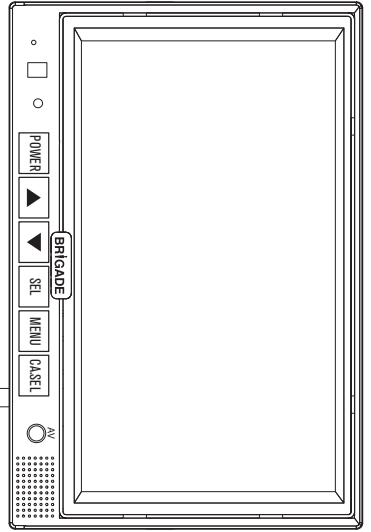

**Red:** Rouge  
Rot  
Rosso  
Rojo  
Rood

**Brown:** Marron  
Marrone  
Braun  
Marrón  
Bruin

**Blue:** Bleu  
Blu  
Blau  
Azul  
Blauw

**Black:** Noir  
Schwarz  
Nero  
Negro  
Zwart

**White:** Blanc  
Weiß  
Bianco  
Blanco  
Wit

**Fuse:** Fusible  
Sicherung  
Fusibile  
Fusible  
Zekering

**Ground:** Terre  
Grund  
Terreno  
Terreno  
Grond

**Trigger:** Déclencher  
Auslösen  
Attivare  
Desencadenar  
Trekker

# 4 Controls

Contrôles/Kontrollen/Controlli/Controles/Controles

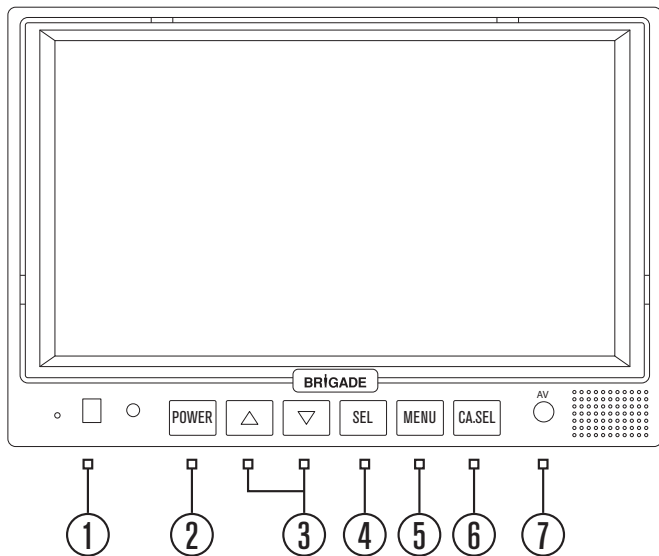

- ① Automatic low light sensor.  
Capteur optique automatique de basse luminosité.  
Automatischer Low-Light Sensor.  
Sensore automatico di bassa luminosità.  
Sensor automático de baja luminosidad.  
Automatische low-light sensor.

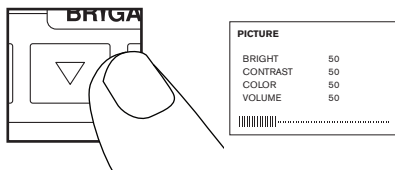
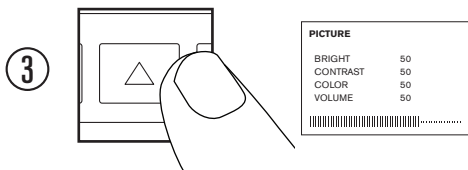
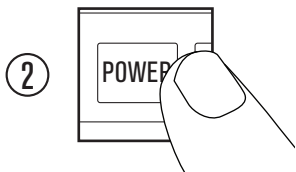

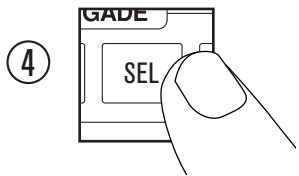

# 4 Controls

Contrôles/Kontrollen/Controlli/Controles/Controles

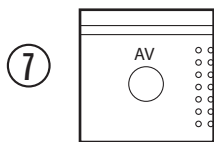
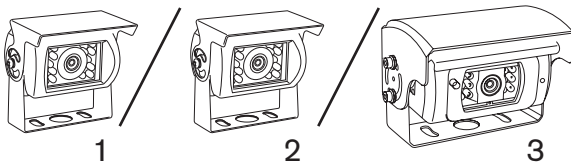
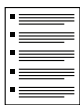
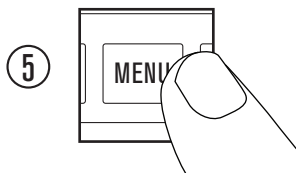

PICTURE	
<b>BRIGHT</b>	50
CONTRAST	50
COLOR	50
VOLUME	50



3.5mm  
Input  
Entrée  
Eingang  
Ingresso  
Entrada  
Invoer



# 5 Operation

Opération/Betrieb/Operazione/Operación/Werking

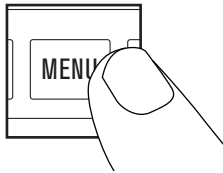

x 20sec

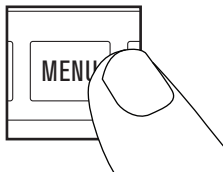

x 2 =

OPTION	
LANG	ENGLISH
SCALE	OFF
CAM 1	NORMAL
CAM 2	NORMAL
CAM 3	NORMAL

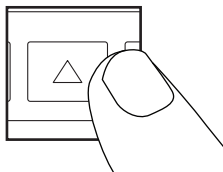

OPTION	
SPRACHE	DEUTSCH
SCALE	OFF
CAM 1	NORMAL
CAM 2	NORMAL
CAM 3	NORMAL

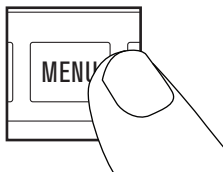

x 1 =

PICTURE	
BRIGHT	50
CONTRAST	50
COLOR	50
VOLUME	50

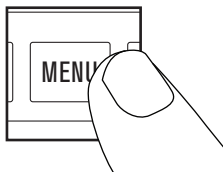

x 3 =

SYSTEM	
COLOR-SYS	PAL
BLUE BACK	OFF
HORIZONTAL	⇌
VERTICAL	⇕
ZOOM	16:9

## 6 Trigger delay

Retard de déclenchement/Trigger verzögerung/Ritardo selettore/  
Retraso disparador/Trigger vertraging

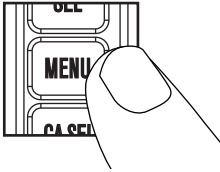

x 4 =

### TRIGGER DELAY

CAM 1 DELAY	3 SEC
CAM 2 DELAY	3 SEC
CAM 3 DELAY	0 SEC

## 7 Set camera to mirror view

Appareil est en miroir de vue/Kamera auf Spiegel Blick/Fotocamera impostata su  
specchio di vista/Cámara en espejo/Cameraposities te bekijken spiegel

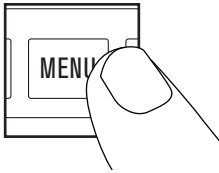

x 2 =

### OPTION

LANG	ENGLISH
SCALE	OFF
CAM 1	NORMAL
CAM 2	NORMAL
CAM 3	NORMAL



x 2 =

### OPTION

LANG	ENGLISH
SCALE	OFF
<b>CAM 1</b>	<b>NORMAL</b>
CAM 2	NORMAL
CAM 3	NORMAL

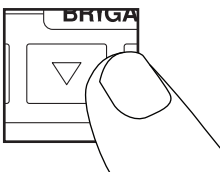

x 1 =

### OPTION

LANG	ENGLISH
SCALE	OFF
<b>CAM 1</b>	<b>MIRROR</b>
CAM 2	NORMAL
CAM 3	NORMAL



# 7 Specifications

Spécifications/ Spezifikationen/ Specifiche/ Especificaciones/ Specificaties

ENGLISH	
Specifications	
Monitor	VBV-770DM-S
TV system	NTSC/PAL
Picture	7" Digital TFT LCD colour monitor with on-screen display function
Display size	7" diagonal
Field of view	Top: 50°, Bottom: 60°, Left: 70°, Right: 70°
Resolution	(800x3(RGB)x480)
Picture image	Factory set to reverse image
Power	12/24Vdc input
Inputs	3 x camera, 1A/V
Dimensions	182(w) x 122(h) x 29.6(d)mm 7.17(w) x 4.8(h) x 1.17(d) inches
Operating temperature	-20°C ~ +70°C -40°F ~ +158°F

FRANCAIS	
Specifications	
Moniteur	BV-770DM-S
Système TV	NTSC/PAL
Image	7" Numérique TFT LCD moniteur couleur avec affichage de fonction (OSD)
Dimension de l'écran	7" diagonale
Champ de vision	Haut: 50°, Bas: 60°, Gauche: 70°, Droite: 70°
Résolution	(800x3(RGB)x480)
Image vidéo	Réglage d'usine sur image inverse
Alimentation	12/24Vdc input
Entrées	3 x caméra, 1A/V
Dimensions	182(w) x 122(h) x 29,6(d)mm 7,17(w) x 4,8(h) x 1,17(d) inches
Température d'utilisation	-20°C ~ +70°C -40°F ~ +158°F

ITALIANO	
Specifiche	
Schermo	BV-770DM-S
Sistema TV	NTSC/PAL
Immagine	7" digital TFT LCD colorare il monitor con la funzione di mostra sullo schermo
Formato display	7" diagonale
Campo visivo	Top: 50°, Bottom: 60°, Left: 70°, Right: 70°
Risoluzione	(800x3(RGB)x480)
Immagine a video	Immagine reversibile program-mabile
Alimentazione	12/24Vdc input
Prese	3 x telecamera, 1A/V
Dimensioni	182(w) x 122(h) x 29.6(d)mm 7.17(w) x 4.8(h) x 1.17(d) inches
Temperatura di servizio	-20°C ~ +70°C -40°F ~ +158°F

DEUTSCH	
Spezifikationen	
Monitor	BV-770DM-S
TV-System	NTSC/PAL
Bild	7" digitalen TFT LCD Farbmonitor mit Funktionsanzeige (OSD)
Bildschirmgröße	7" diagonal
Sichtfeld	Oben: 50°, Unten: 60°, Links: 70°, Rechts: 70°
Auflösung	(800x3(RGB)x480)
Videobild	Werkseinstellung Reversebild
Stromversorgung	12/24Vdc input
Eingänge	3 x kamera, 1A/V
Abmessungen	182(w) x 122(h) x 29.6(d)mm 7.17(w) x 4.8(h) x 1.17(d) inches
Betriebstemperatur	-20°C ~ +70°C -40°F ~ +158°F

# 7 Specifications

**Spécifications/ Spezifikationen/Specifiche/Especificaciones/Specificaties**

<b>ESPAÑOL</b>	
<b>Especificaciones</b>	
Monitor	BV-770DM-S
Sistema de TV	NTSC/PAL
Imagen	Monitor a color de 7" digital TFT LCD con visualización de las funciones (OSD)
Tamaño de pantalla	7" diagonal
Campo visual	arriba: 50°, abajo: 60°, a la izquierda: 70°, a la derecha: 70°
Resolución	(800x3(RGB)x480)
Imagen de video	Ajuste de fábrica de la imagen inversa
Suministro de corriente	12/24Vdc entrada
Entradas	3 x cámara, 1 A/V
Dimensiones	182(w) x 122(h) x 29.6(d)mm 7.17(w) x 4.8(h) x 1.17(d) inches
Temperatura de servicio	-20°C ~ +70°C -40°F ~ +158°F

<b>NEDERLANDS</b>	
<b>Specificaties</b>	
Monitor	BV-770DM-S
TV-systeem	NTSC/PAL
Beeld	7" digitale TFT LCD kleurenmonitor met on-screen display functie
Displayformaat	7" diagonaal
Gezichtsveld	Boven: 50°, Onder: 60°, Links: 70°, Rechts: 70°
Resolutie	(800x3(RGB)x480)
Videobeeld	Fabrieksinstelling reversebeeld
Stroomvoorziening	12/24Vdc Ingang
Ingangen	3 x camera, 1 A/V
Afmetingen	182(w) x 122(h) x 29.6(d)mm 7.17(w) x 4.8(h) x 1.17(d) inches
Bedrijfstemperatuur	-20°C ~ +70°C -40°F ~ +158°F

Specifications subject to change. Sous réserve de modifications techniques. Vorbehaltlich technischer Änderungen. Con riserva di modifichite tecniche. Reservadas las modificaciones técnicas. Technische wijzigingen voorbehouden.

**Disclaimer**

Camera monitor systems are an invaluable driver aid but do not exempt the driver from taking every normal precaution when conducting a manoeuvre. No liability arising out of the use or failure of the product can in any way be attached to Brigade or to the distributor.

**Dénégation**

Les systèmes de moniteurs des caméras sont une aide précieuse pour le conducteur, mais celui-ci doit toutefois prendre toutes les précautions nécessaires pendant les manœuvres. Brigade ou ses distributeurs n'assument aucune responsabilité résultant de l'utilisation ou d'un défaut du produit.

**Verzichtklärung**

Die Kamerabildschirmssysteme sind eine wertvolle Hilfe für den Fahrer, entbinden ihn jedoch nicht von der notwendigen Sorgfalt beim Manövrieren des Fahrzeuges. Brigade und seine Vertriebshändler haften nicht für Schäden aus der Nutzung oder einer Fehlfunktion des Produktes.

**Disconoscimento**

I sistemi di monitor della telecamera sono un aiuto prezioso per il conduttore, ma non lo esonerano dall'obbligo di prendere le precauzioni necessarie durante le manovre del veicolo. Brigade e i suoi distributori non si assumono nessuna responsabilità per danni risultanti dall'utilizzo o da un malfunzionamento del prodotto.

**Negante**

Los sistemas de pantalla de cámara son una valiosa ayuda destinada a los conductores; en todo caso no les resta la responsabilidad de proceder con precaución a la hora de maniobrar con el vehículo. Brigade y sus distribuidores comerciales no se responsabilizan de los daños derivados de un mal funcionamiento del producto.

**Verwerping**

De camera-monitorsystemen zijn een waardevolle hulp voor de bestuurder, ontheffen hem echter niet van de nodige zorgvuldigheid bij het manoeuvreren van het voertuig. Brigade en zijn distributeurs zijn niet aansprakelijk voor schade door gebruik of een gebrek van het product.

Serial No:

Stock code:

## Head Office

Brigade Electronics Plc  
Brigade House, The Mills  
Station Road, South Darenth  
DA4 9BD United Kingdom  
Tel: +44 (0)1322 420300  
Fax: +44 (0)1322 420343  
email: sales@brigade-electronics.com

## Brigade Electronics Inc

202 Delaware Avenue, Suite 1  
Palmerton PA 18071 USA  
Tel: +1 (610) 826-7870  
Fax: +1 (484) 229-0088  
email: infousa@brigade-electronics.com

## Brigade Electronique Sarl

22 Rue Pierre Bontemps  
72000 Le Mans  
France  
Tel: +33 (0) 2 23 61 08 97  
Fax +33 (0) 2 23 61 08 97  
email: info@brigade-electronique.fr

## Brigade Elettronica srl

Via V. Alfieri, 28  
50121 Firenze  
Italia  
Telefono: +39 (0) 55-245943  
Fax: +44 (0) 1322 420343 (servizio clienti)  
email: info-italia@brigade-electronics.com

## Brigade Elektronik GmbH

Haberstr. 21  
24539 Neumünster Germany  
Telefon: +49 (0) 4321 555 360  
Fax: +49 (0) 4321 555 361  
email: info@brigadegmbh.de

## Brigade Elektronika (PTY) Ltd

P.O. Box 53203  
Wierdapark 0149  
South Africa  
Tel: +27 (0) 72 757 7166  
Fax: +27 (0) 866 963 238  
email: brigade@ballmail.co.za

## Brigade Electronics BV

Gesseltweg 4  
6089 NT Heibloem  
The Netherlands  
Tel: +31 475 44 06 23  
Fax: +31 475 49 54 76  
email: info@brigade-electronics.nl

